



OPEN

Industry Standard, Flexible Architecture

GREEN

Less Heat, Less Power Consumption

STABLE

Robust Design, Quality Parts

Stable and
Reliable Solution

Server/Workstation

Motherboard

C2750D4I+

C2750D4I

C2550D4I

User Manual

English



Version 1.0

Published January 2015

Copyright©2015 ASRock Rack Inc. All rights reserved.

Copyright Notice:

No part of this documentation may be reproduced, transcribed, transmitted, or translated in any language, in any form or by any means, except duplication of documentation by the purchaser for backup purpose, without written consent of ASRock Rack Inc.

Products and corporate names appearing in this documentation may or may not be registered trademarks or copyrights of their respective companies, and are used only for identification or explanation and to the owners' benefit, without intent to infringe.

Disclaimer:

Specifications and information contained in this documentation are furnished for informational use only and subject to change without notice, and should not be constructed as a commitment by ASRock Rack. ASRock Rack assumes no responsibility for any errors or omissions that may appear in this documentation.

With respect to the contents of this documentation, ASRock Rack does not provide warranty of any kind, either expressed or implied, including but not limited to the implied warranties or conditions of merchantability or fitness for a particular purpose.

In no event shall ASRock Rack, its directors, officers, employees, or agents be liable for any indirect, special, incidental, or consequential damages (including damages for loss of profits, loss of business, loss of data, interruption of business and the like), even if ASRock Rack has been advised of the possibility of such damages arising from any defect or error in the documentation or product.



This device complies with Part 15 of the FCC Rules. Operation is subject to the following two conditions:

- (1) this device may not cause harmful interference, and
- (2) this device must accept any interference received, including interference that may cause undesired operation.

CALIFORNIA, USA ONLY

The Lithium battery adopted on this motherboard contains Perchlorate, a toxic substance controlled in Perchlorate Best Management Practices (BMP) regulations passed by the California Legislature. When you discard the Lithium battery in California, USA, please follow the related regulations in advance.

“Perchlorate Material-special handling may apply, see www.dtsc.ca.gov/hazardouswaste/perchlorate”

ASRock Rack's Website: www.ASRockRack.com

Contact Information

If you need to contact ASRock Rack or want to know more about ASRock Rack, you're welcome to visit ASRock Rack's website at www.ASRockRack.com; or you may contact your dealer for further information.

ASRock Rack Incorporation

6F., No.37, Sec. 2, Jhongyang S. Rd., Beitou District,

Taipei City 112, Taiwan (R.O.C.)

Contents

Chapter 1 Introduction	1
1.1 Package Contents	1
1.2 Specifications	2
1.3 Unique Features	5
1.4 Motherboard Layout	6
1.5 Onboard LED Indicators	10
1.6 I/O Panel	12
1.7 Block Diagram	14
Chapter 2 Installation	15
2.1 Screw Holes	15
2.2 Pre-installation Precautions	15
2.3 Installation of Memory Modules (DIMM)	16
2.4 Expansion Slots (PCI Express Slots)	18
2.5 Jumper Setup	19
2.6 Onboard Headers and Connectors	20
2.7 Unit Identification purpose LED/Switch	25
2.8 Driver Installation Guide	25
Chapter 3 UEFI Setup Utility	26
3.1 Introduction	26
3.1.1 UEFI Menu Bar	26
3.1.2 Navigation Keys	27
3.2 Main Screen	28
3.3 Advanced Screen	29

3.3.1	Easy Raid Installer	30
3.3.2	Storage Configuration	31
3.3.3	ACPI Configuration	32
3.3.4	Super IO Configuration	33
3.4	H/W Monitor Screen (Hardware Health Event Monitoring)	38
3.5	IntelRCSetup	40
3.5.1	Processor Configuration	41
3.5.2	North Bridge Configuration	43
3.5.3	South Bridge Chipset Configuration	44
3.5.4	System Event Log	46
3.6	Server Management	47
3.7	Event Logs	50
3.8	Security Screen	51
3.9	Boot Screen	52
3.10	Exit Screen	54
	Chapter 4 Software Support	55
4.1	Install Operating System	55
4.2	Support CD Information	55
4.2.1	Running The Support CD	55
4.2.2	Drivers Menu	55
4.2.3	Utilities Menu	55
4.2.4	Contact Information	55

Chapter 5 Troubleshooting	56
5.1 Troubleshooting Procedures	56
5.2 Technical Support Procedures	58
5.3 Returning Merchandise for Service	58
Chapter 6: Net Framework Installation Guide	59
6.1 Installing .Net Framework 3.5.1 (For Server 2008 R2)	59

Chapter 1 Introduction

Thank you for purchasing ASRock Rack **C2X50D4I Series** motherboard, a reliable motherboard produced under ASRock Rack's consistently stringent quality control. It delivers excellent performance with robust design conforming to ASRock Rack's commitment to quality and endurance.

In this manual, chapter 1 and 2 contains introduction of the motherboard and step-by-step guide to the hardware installation. Chapter 3 and 4 contains the configuration guide to BIOS setup and information of the Support CD.



Because the motherboard specifications and the BIOS software might be updated, the content of this manual will be subject to change without notice. In case any modifications of this manual occur, the updated version will be available on ASRock Rack website without further notice. You may find the latest memory and CPU support lists on ASRock Rack website as well. ASRock Rack's Website: www.ASRockRack.com

*If you require technical support related to this motherboard, please visit our website for specific information about the model you are using.
<http://www.asrockrack.com/support/>*

1.1 Package Contents

- ASRock Rack C2550D4I / C2750D4I / C2750D4I+ Motherboard
(Mini-ITX Form Factor: 6.7-in x 6.7-in, 17.0 cm x 17.0 cm)
- Support CD
- User Manual
- 6 x Serial ATA (SATA) Cables (Optional)
- 1 x I/O Shield



If any items are missing or appear damaged, contact your authorized dealer.

1.2 Specifications

C2550D4I / C2750D4I / C2750D4I+	
MB Physical Status	
Form Factor	Mini-ITX
Dimension	6.7" x 6.7" (17.0 cm x 17.0 cm)
Processor System	
CPU	C2750D4I / C2750D4I+: Intel® Octa Core Avoton C2750 Processor C2550D4I: Intel® Octa Core Avoton C2550 Processor
Socket	FCBGA1283 SOC
System Memory	
Max. Capacity	64GB DDR3 ECC UDIMM
Socket	- 4 x 240-pin DDR3 DIMM slots - Support up to 64GB DDR3 ECC and UDIMM
Type	- Dual Channel DDR3 memory technology - Supports DDR3 1600/1333 ECC and UDIMM
Voltage	1.5V, 1.35V
Expansion Slot	
PCIe 2.0 x 8	1 slot (x8 mode)
Storage	
SATA Controller	C2750D4I / C2750D4I+: Intel® C2750 : 2 x SATA3 6.0 Gb/s, 4 x SATA2 3.0 Gb/s C2550D4I: Intel® C2550 : 2 x SATA3 6.0 Gb/s, 4 x SATA2 3.0 Gb/s
Additional SATA Controller	- Marvell SE9172: 2 x SATA3 6.0 Gb/s, support RAID 0, 1 - Marvell SE9230: 4 x SATA3 6.0 Gb/s, support RAID 0, 1, 10
Ethernet	
Interface	Gigabit LAN 10/100/1000 Mb/s
LAN Controller	- 2 x Intel® i210 - Supports Wake-On-LAN - Supports Energy Efficient Ethernet 802.3az - Supports Dual LAN with Teaming function - Supports PXE
Management	
BMC Controller	ASPEED AST2300 : IPMI (Intelligent Platform Management Interface) 2.0 with iKVM support
IPMI Dedicated GLAN	1 x Realtek RTL8211E for dedicated management GLAN
Features	- Watch Dog - NMI

Graphics	
Controller	ASPEED AST2300
VRAM	DDR3 16MB
Output	Supports D-Sub with max. resolution up to 1920x1200 @ 60Hz
Rear Panel I/O	
VGA Port	1 x D-Sub
USB 2.0 Port	2
LAN Port	- 2 x RJ45 Gigabit Ethernet LAN ports - 1 x RJ45 Dedicated IPMI LAN port - LAN Ports with LED (ACT/LINK LED and SPEED LED)
Serial Port	1 (COM1)
UID Button/UID LED	1
Internal Connector	
Auxiliary Panel Header	1 (includes location button & LED, front LAN LED)
IPMB Header	1
Fan Header	6 x 4-pin
ATX Power	1 (24-pin)
USB 2.0 Header	1 (support 1 via headers or 2 via headers controlled by USB_SEL1 and USB_SEL2 jumper)
Front Panel	1
System BIOS	
BIOS Type	64Mb AMI UEFI Legal BIOS
BIOS Features	- Plug and Play (PnP) - ACPI 1.1 Compliance Wake Up Events - SMBIOS 2.3.1 Support - DRAM Voltage Multi-adjustment - ASRock Rack Instant Flash
Hardware Monitor	
Temperature	- CPU Temperature Sensing - Motherboard Temperature Sensing
Fan	- CPU/Rear/Front Fan Tachometer - CPU Quiet Fan (Allow CPU Fan Speed Auto-Adjust by CPU Temperature) - CPU/Rear/Front Fan Multi-Speed Control
Voltage	Voltage Monitoring: +12V, +5V, +3.3V, CPU Vcore, DRAM, +1.1V, +1.0V, +BAT, 3VSB, 5VSB

Support OS

OS	<p>Microsoft® Windows®</p> <ul style="list-style-type: none">- Server 2008 R2 SP1 (64 bit)- Server 2012 (64 bit) <p>Linux®</p> <ul style="list-style-type: none">- CentOS 6.4/5.10 (x32 and x64) (only support AHCI mode)- SUSE Enterprise Linux Server 11 SP1 (32 / 64 bit)- FreeBSD 9.1 (32 / 64 bit)- Fedora Core 19 (64 bit)- Ubuntu 12.04/12.10 (64 bit) <p>Virtual:</p> <ul style="list-style-type: none">- VMWare ESXi 5.5
----	--

Environment

Temperature	<p>Operation temperature: 10°C ~ 35°C / Non operation temperature: -40°C ~ 70°C</p> <p><i>*For C2750D41 / C2550D41 motherboard, please install a CPU fan when the airflow through the heat sink is below 2 CFM(Cubic Feet per Minute) for better ventilation.</i></p>
-------------	---

* For detailed product information, please visit our website: <http://www.asrockrack.com>



Since Intel® Edisonville platform does not support RSTe feature, it is decided by OS inbox driver behavior. The Avoton processor integrated I/O's SATA2/3 driver is used in box not Intel®. So according to Windows® 2008 R2 OS operation behaviors, it needs to take about ~60sec refresh timer when users unplug SATA device. You have to go in manually to detect the drive and recognize it. In other words, the operation system will quickly response the SATA plug in/out status about ~10sec when users install the RSTe driver if the platform supports it.

1.3 Unique Features

ASRock Instant Flash is a BIOS flash utility embedded in Flash ROM. This convenient BIOS update tool allows you to update system BIOS without entering operating systems first like MS-DOS or Windows[®]. With this utility, you can press the <F6> key during the POST or the <F2> key to enter into the BIOS setup menu to access ASRock Rack Instant Flash. Just launch this tool and save the new BIOS file to your USB flash drive, floppy disk or hard drive, then you can update your BIOS only in a few clicks without preparing an additional floppy diskette or other complicated flash utility. Please be noted that the USB flash drive or hard drive must use FAT32/16/12 file system.

1.4 Motherboard Layout

C2750D4I

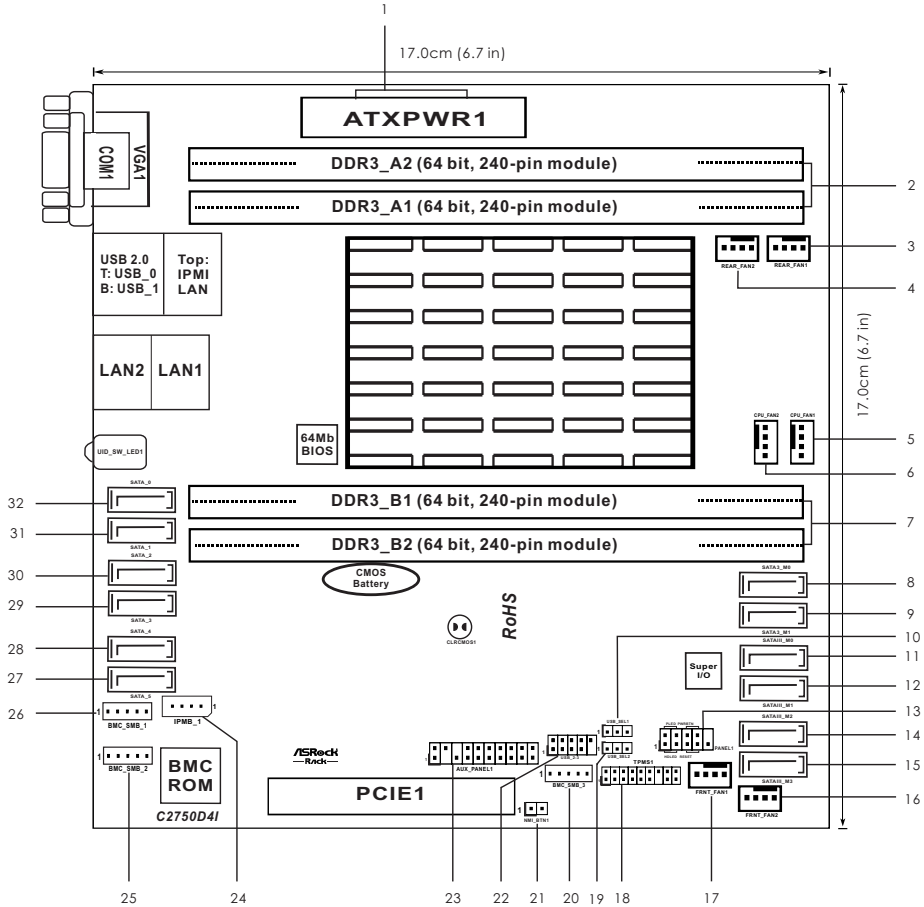

C2750D4I+

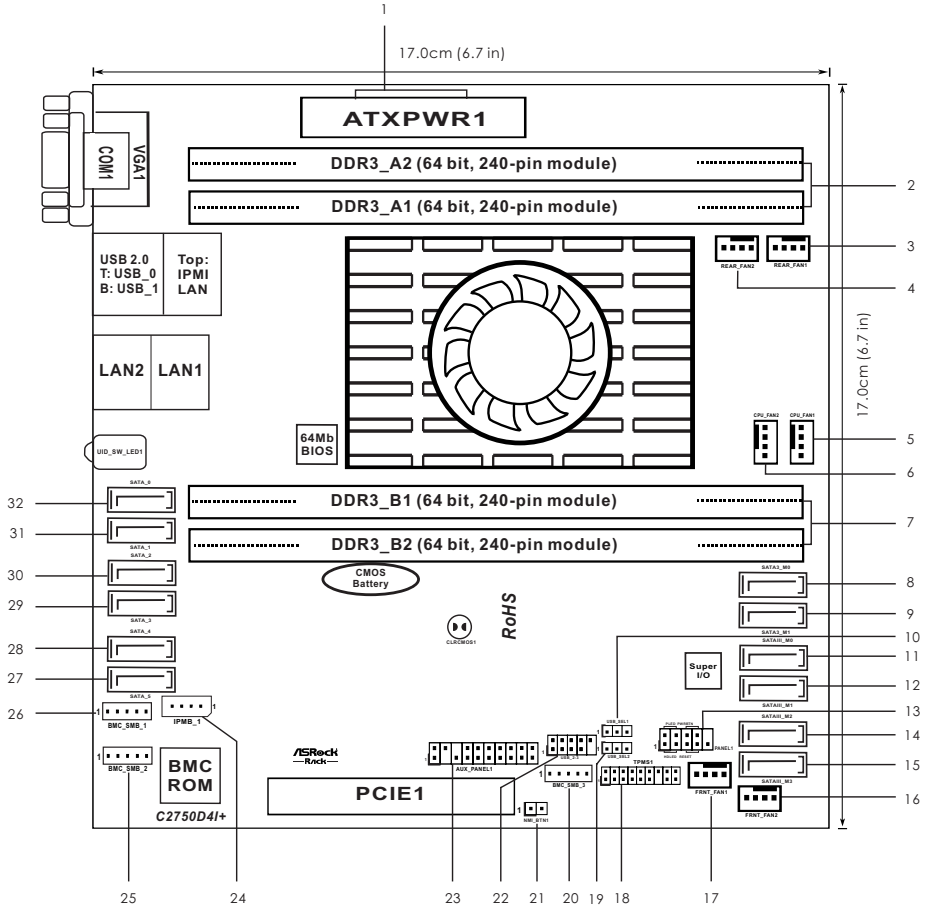

C2550D4I

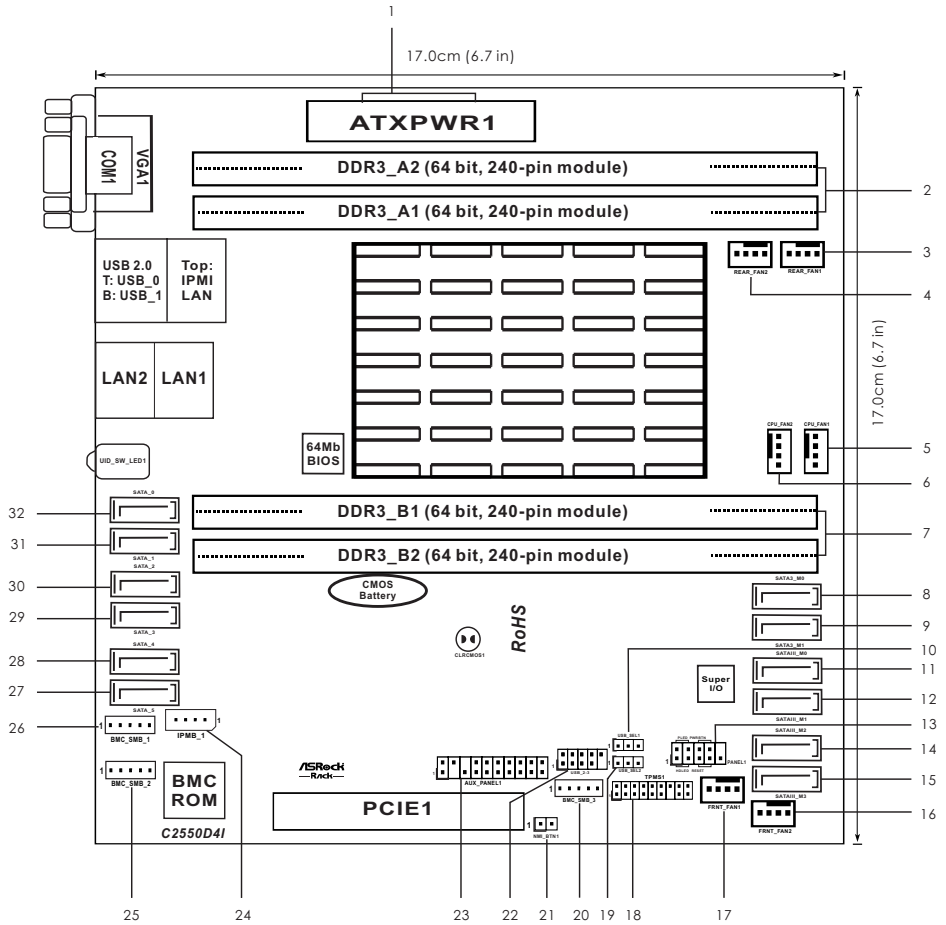

No.	Description
1	ATX Power Connector (ATXPWR1)
2	2 x 240-pin DDR3 DIMM Slots (DDR3_A1, DDR3_A2)
3	Rear Fan Connector (REAR_FAN1)
4	Rear Fan Connector (REAR_FAN2)
5	CPU Fan Connector (CPU_FAN1)
6	CPU Fan Connector (CPU_FAN2)
7	2 x 240-pin DDR3 DIMM Slots (DDR3_B1, DDR3_B2)
8	SATA3 Connector (SATA3_M0, White)
9	SATA3 Connector (SATA3_M1, White)
10	USB Selection Jumper (USB_SEL1)
11	SATA3 Connector (SATAIII_M0, White)
12	SATA3 Connector (SATAIII_M1, White)
13	System Panel Header (PANEL1)
14	SATA3 Connector (SATAIII_M2, White)
15	SATA3 Connector (SATAIII_M3, White)
16	Front Fan Connector (FRNT_FAN2)
17	Front Fan Connector (FRNT_FAN1)
18	TPM Header (TPMS1)
19	USB Selection Jumper (USB_SEL2)
20	BMC SMB Header (BMC_SMB3)
21	Non Maskable Interrupt Button (NMI_BTN1)
22	USB 2.0 Header (USB_2-3)
23	Auxiliary Panel Header (AUX_PANEL1)
24	Intelligent Platform Management Bus header (IPMB_1)
25	BMC SMB Header (BMC_SMB2)
26	BMC SMB Header (BMC_SMB1)
27	SATA2 Connector (SATA_5, Blue)
28	SATA2 Connector (SATA_4, Blue)
29	SATA2 Connector (SATA_3, Blue)
30	SATA2 Connector (SATA_2, Blue)
31	SATA3 Connector (SATA_1, White)
32	SATA3 Connector (SATA_0, White)

1.5 Onboard LED Indicators

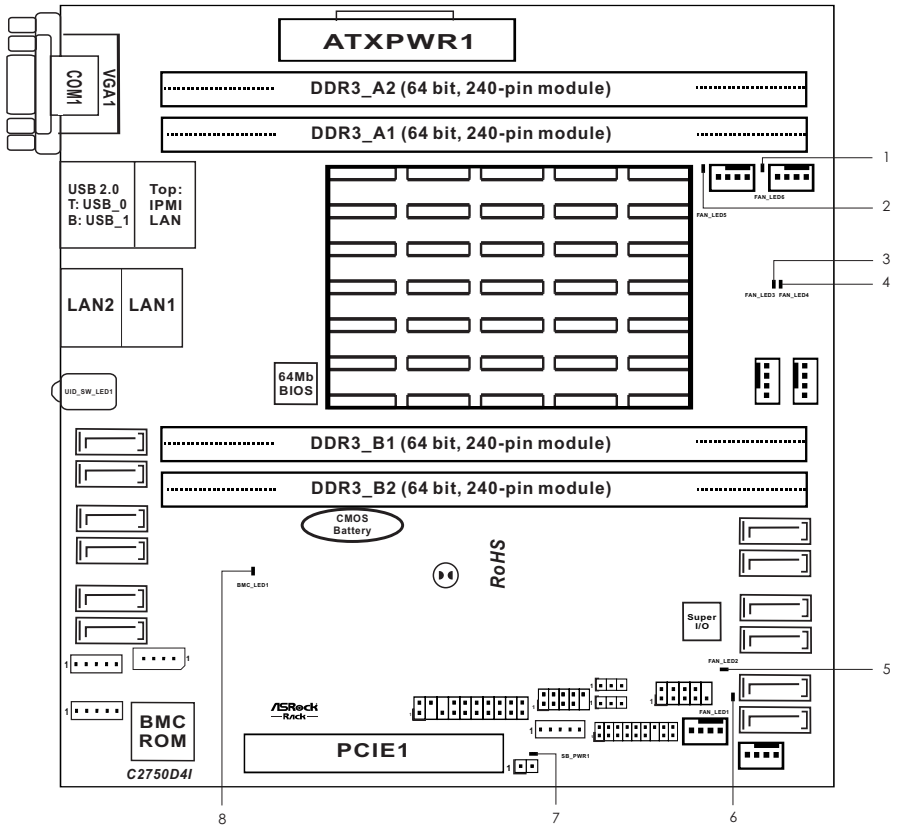

No.	Status	Description
1	Amber	Rear_FAN2 failed
2	Amber	Rear_FAN1 failed
3	Amber	CPU_FAN1 failed
4	Amber	CPU_FAN2 failed
5	Amber	Front_FAN2 failed
6	Amber	Front_FAN1 failed
7	Green	STB PWR ready
8	Green	BMC heartbeat LED

1.6 I/O Panel

C2550D4I / C2750D4I / C2750D4I+

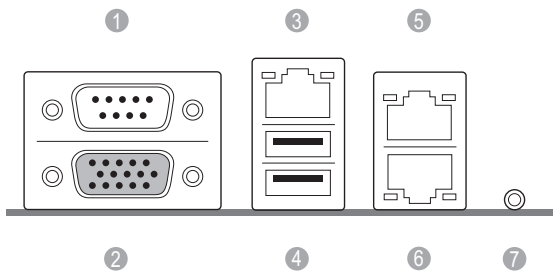

No.	Description	No.	Description
1	Serial Port (COM1)	5	LAN RJ-45 Port (LAN1)**
2	D-Sub Port (VGA1)	6	LAN RJ-45 Port (LAN2)**
3	Dedicated IPMI LAN Port*	7	UID Switch/LED (UID_SW_LED1)
4	USB 2.0 Ports (USB_0-1)		

LAN Port LED Indications

*There are two LED next to the LAN port. Please refer to the table below for the LAN port LED indications.

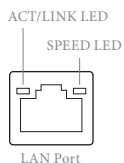

Dedicated IPMI LAN Port LED Indications

Activity / Link LED		Speed LED	
Status	Description	Status	Description
Off	No Link	Off	10Mbps connection
Blinking	Data Activity	Orange	100Mbps connection
On	100Mbps connection	Green	1Gbps connection

**There are two LEDs on each LAN port. Please refer to the table below for the LAN port LED indications.

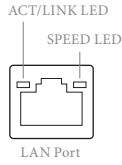

LAN Port (LAN1, LAN2) LED Indications

Activity / Link LED		Speed LED	
Status	Description	Status	Description
Off	No Link	Off	10Mbps connection
Blinking	Data Activity	Off	100Mbps connection
On	100Mbps connection	Green	1Gbps connection

1.7 Block Diagram

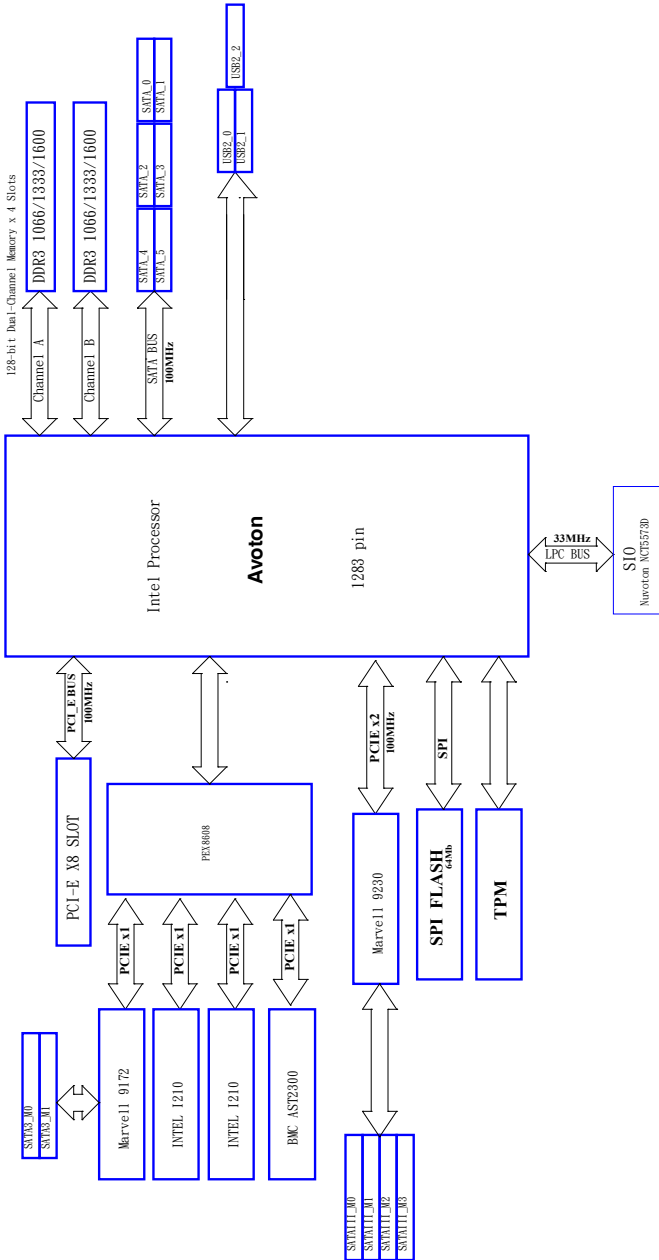

Chapter 2 Installation

This is a Mini-ITX form factor (6.7" x 6.7", 17.0 cm x 17.0 cm) motherboard. Before you install the motherboard, study the configuration of your chassis to ensure that the motherboard fits into it.



Make sure to unplug the power cord before installing or removing the motherboard. Failure to do so may cause physical injuries to you and damages to motherboard components.

2.1 Screw Holes

Place screws into the holes indicated by circles to secure the motherboard to the chassis.



Do not over-tighten the screws! Doing so may damage the motherboard.

2.2 Pre-installation Precautions

Take note of the following precautions before you install motherboard components or change any motherboard settings.

1. Unplug the power cord from the wall socket before touching any components.
2. To avoid damaging the motherboard's components due to static electricity, **NEVER** place your motherboard directly on the carpet or the like. Also remember to use a grounded wrist strap or touch a safety grounded object before you handle the components.
3. Hold components by the edges and do not touch the ICs.
4. Whenever you uninstall any component, place it on a grounded anti-static pad or in the bag that comes with the component.
5. When placing screws into the screw holes to secure the motherboard to the chassis, please do not over-tighten the screws! Doing so may damage the motherboard.



Before you install or remove any component, ensure that the power is switched off or the power cord is detached from the power supply. Failure to do so may cause severe damage to the motherboard, peripherals, and/or components.

2.3 Installation of Memory Modules (DIMM)

This motherboard provides four 240-pin DDR3 (Double Data Rate 3) DIMM slots, and supports Dual Channel Memory Technology.



1. For dual channel configuration, you always need to install identical (the same brand, speed, size and chip-type) DDR3 DIMM pairs.
2. It is not allowed to install a DDR or DDR2 memory module into a DDR3 slot; otherwise, this motherboard and DIMM may be damaged.
3. Please install the memory module on DDR3_A1 for the first priority.
4. To activate Dual Channel Memory Technology, please follow the “Dual Channel Memory Configuration” table below.

Dual Channel Memory Configuration

Priority	DDR3_A1 (Blue)	DDR3_A2 (White)	DDR3_B1 (Blue)	DDR3_B2 (White)
1	Populated		Populated	
2	Populated	Populated	Populated	Populated

**Since installing three memory modules is NOT supported on this motherboard, we suggest not using this configuration.*



The DIMM only fits in one correct orientation. It will cause permanent damage to the motherboard and the DIMM if you force the DIMM into the slot at incorrect orientation.

1

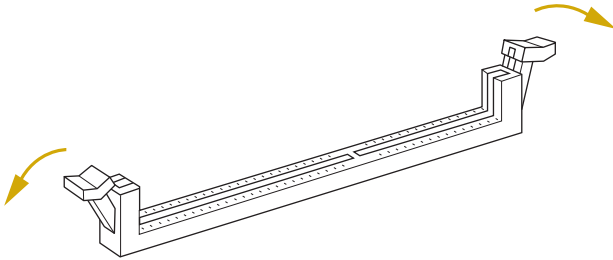

2

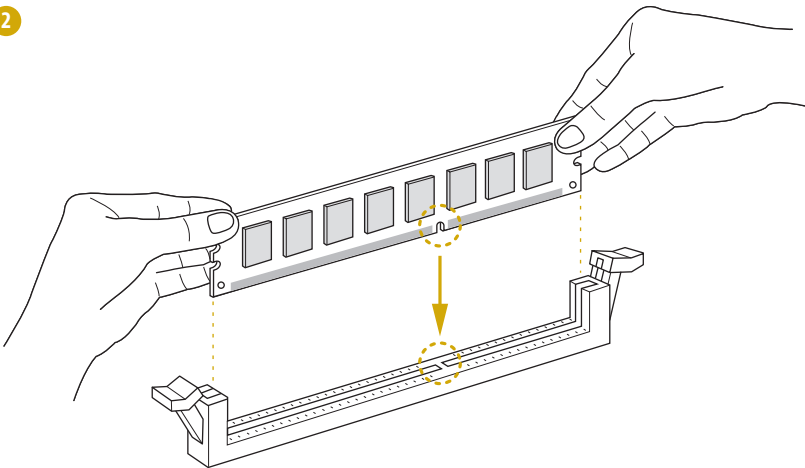

3

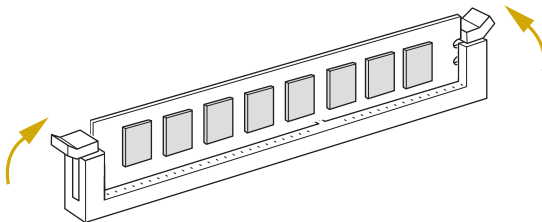

2.4 Expansion Slots (PCI Express Slots)

There is 1 PCI Express slots on this motherboard.

PCIE slot:

PCIE1 (PCIe 2.0 x8 slot) is used for PCI Express x8 lane width cards.

Installing an expansion card

- Step 1. Before installing an expansion card, please make sure that the power supply is switched off or the power cord is unplugged. Please read the documentation of the expansion card and make necessary hardware settings for the card before you start the installation.
- Step 2. Remove the system unit cover (if your motherboard is already installed in a chassis).
- Step 3. Remove the bracket facing the slot that you intend to use. Keep the screws for later use.
- Step 4. Align the card connector with the slot and press firmly until the card is completely seated on the slot.
- Step 5. Fasten the card to the chassis with screws.
- Step 6. Replace the system cover.

2.5 Jumper Setup

The illustration shows how jumpers are setup. When the jumper cap is placed on the pins, the jumper is “Short”. If no jumper cap is placed on the pins, the jumper is “Open”. The illustration shows a 3-pin jumper whose pin1 and pin2 are “Short” when a jumper cap is placed on these 2 pins.

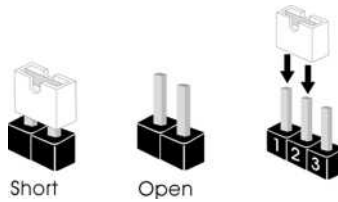

USB Selection Jumper
(3-pin USB_SEL1)
(No. 10)
(3-pin USB_SEL2)
(No. 19)



Support:
Rear USB 2.0 ports x 2
Front USB header x 1
(Default)



Support:
Rear USB 2.0 ports x 1
Front USB header x 2

2.6 Onboard Headers and Connectors



Onboard headers and connectors are NOT jumpers. Do NOT place jumper caps over these headers and connectors. Placing jumper caps over the headers and connectors will cause permanent damage to the motherboard.

*You can see p.6 or p.7 for motherboard layout.

Serial ATA3 Connectors

(SATA_0: No. 32)
(SATA_1: No. 31)
(SATA3_M0: No. 8)
(SATA3_M1: No. 9)
(SATAIII_M0: No. 11)
(SATAIII_M1: No. 12)
(SATAIII_M2: No. 14)
(SATAIII_M3: No. 15)



SATA_0



SATA3_M0



SATA_1



SATA3_M1



SATAIII_M0



SATAIII_M1



SATAIII_M2



SATAIII_M3

These eight Serial ATA3 (SATA3) connectors support SATA data cables for internal storage devices. The current SATA3 interface allows up to 6.0 Gb/s data transfer rate.

Serial ATA2 Connectors

(SATA_2: No. 30)
(SATA_3: No. 29)
(SATA_4: No. 28)
(SATA_5: No. 27)



SATA_2



SATA_3



SATA_4



SATA_5

These four Serial ATA2 (SATA2) connectors support SATA data cables for internal storage devices. The current SATA2 interface allows up to 3.0 Gb/s data transfer rate.

USB 2.0 Header

(9-pin USB_2-3)
(No. 22)

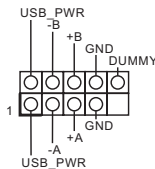

Besides two default USB 2.0 ports on the I/O panel, there is one USB 2.0 header on this motherboard. Each USB 2.0 header can support two USB 2.0 ports.

TPM Header
(17-pin TPMS1)
(No. 18)

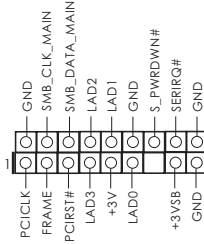

This connector supports Trust-eed Platform Module (TPM) system, which can securely store keys, digital certificates, passwords, and data. A TPM system also helps enhance network security, protects digital identities, and ensures platform integrity.

System Panel Header
(9-pin PANEL1)
(No. 13)

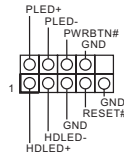

This header accommodates several system front panel functions.



PWRBTN (Power Switch):

Connect to the power switch on the chassis front panel. You may configure the way to turn off your system using the power switch.

RESET (Reset Switch):

Connect to the reset switch on the chassis front panel. Press the reset switch to restart the computer if the computer freezes and fails to perform a normal restart.

PLED (System Power LED):

Connect to the power status indicator on the chassis front panel. The LED is on when the system is operating. The LED is off when the system is in powered off (S5).

HDLED (Hard Drive Activity LED):

Connect to the hard drive activity LED on the chassis front panel. The LED is on when the hard drive is reading or writing data.

The front panel design may differ by chassis. A front panel module mainly consists of power switch, reset switch, power LED, hard drive activity LED, speaker and etc. When connecting your chassis front panel module to this header, make sure the wire assignments and the pin assignments are matched correctly.

Auxiliary Panel Header
(18-pin AUX_PANEL1)
(No. 14)

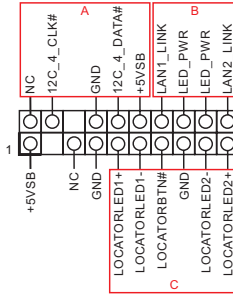

This header supports multiple functions on the front panel, including front panel SMB, internet status indicator.



A. Front panel SMBus connecting pin (6-1 pin FPSMB)

This header allows you to connect SMBus (System Management Bus) equipment. It can be used for communication between peripheral equipment in the system, which has slower transmission rates, and power management equipment.

B. Internet status indicator (2-pin LAN1_LED, LAN2_LED)

These two 2-pin headers allow you to use the Gigabit internet indicator cable to connect to the LAN status indicator. When this indicator flickers, it means that the internet is properly connected.

C. Locator LED (6-pin LOCATOR)

This header is for the locator switch and LED on the front panel.

Front and Rear
Fan Connectors
(4-pin FRNT_FAN1)
(No. 17)

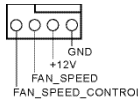

(4-pin FRNT_FAN2)
(No. 16)

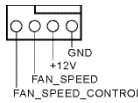

(4-pin REAR_FAN1)
No. 3)

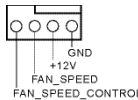

(4-pin REAR_FAN2)
(No. 4)

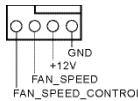

Please connect the fan cables to the fan connectors and match the black wire to the ground pin. All fans supports Fan Control.

CPU Fan Connectors
(4-pin CPU_FAN1)
(No. 5)

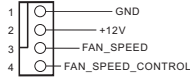

(4-pin CPU_FAN2)
(No. 6)

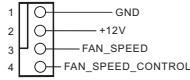

Please connect the CPU fan cable to the connector and match the black wire to the ground pin.

Though this motherboard provides a 4-Pin CPU fan (Quiet Fan) connector, 3-Pin CPU fans can still work successfully even without the fan speed control function. If you plan to connect a 3-Pin CPU fan to the CPU fan connector on this motherboard, please connect it to Pin 1-3.

**For more details, please refer to the Cooler QVL list on the ASRock Rack website.*

ATX Power Connector
(24-pin ATXPWR1)
(No. 1)

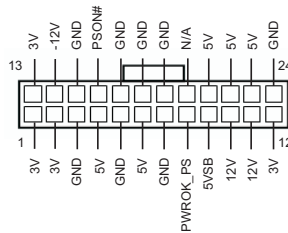

Please connect an ATX power supply to this connector.

Though this motherboard provides a 24-pin ATX power connector, it can still work if you adopt a traditional 20-pin ATX power supply. To use a 20-pin ATX power supply, please plug your power supply along Pin 1 and Pin 13.

Intelligent Platform
Management Bus header
(4-pin IPMB_1)
(No. 24)

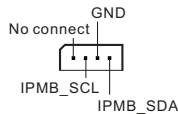

This 4-pin connector is used to provide a cabled baseboard or front panel connection for value added features and 3rd-party add-in cards, such as Emergency Management cards, that provide management features using the IPMB.

Non Maskable Interrupt
Button Header
(2-pin NMI_BTN1)
(see p.13 or 15, No. 21)



Please connect a NMI device to
this header.

BMC SMB Headers
(5-pin BMC_SMB_1)
(No. 26)



This header is used for the SM
BUS devices.

(5-pin BMC_SMB_2)
(No. 25)



(5-pin BMC_SMB_3)
(No. 20)



2.7 Unit Identification purpose LED/Switch

With the UID button, You are able to locate the server you're working on from behind a rack of servers.

Unit Identification
purpose LED/Switch
(UID_SW_LED1)



When the UID button on the front or rear panel is pressed, the front/rear UID blue LED indicator will be turned on. Press the UID button again to turn off the indicator.

2.8 Driver Installation Guide

To install the drivers to your system, please insert the support CD to your optical drive first. Then, the drivers compatible to your system can be auto-detected and listed on the support CD driver page. Please follow the order from top to bottom to install those required drivers. Therefore, the drivers you install can work properly.

Chapter 3 UEFI Setup Utility

3.1 Introduction

This section explains how to use the UEFI SETUP UTILITY to configure your system. The UEFI chip on the motherboard stores the UEFI SETUP UTILITY. You may run the UEFI SETUP UTILITY when you start up the computer. Please press <F2> or during the Power-On-Self-Test (POST) to enter the UEFI SETUP UTILITY; otherwise, POST will continue with its test routines.

If you wish to enter the UEFI SETUP UTILITY after POST, restart the system by pressing <Ctrl> + <Alt> + <Delete>, or by pressing the reset button on the system chassis. You may also restart by turning the system off and then back on.



Because the UEFI software is constantly being updated, the following UEFI setup screens and descriptions are for reference purpose only, and they may not exactly match what you see on your screen.

3.1.1 UEFI Menu Bar

The top of the screen has a menu bar with the following selections:

Item	Description
Main	To set up the system time/date information
Advanced	To set up the advanced UEFI features
H/W Monitor	To display current hardware status
IntelRCSetup	For Intel CPU and chipset settings
Server Mgmt	To manage the server
Event Logs	For event log configuration
Security	To set up the security features
Boot	To set up the default system device to locate and load the Operating System
Exit	To exit the current screen or the UEFI SETUP UTILITY

Use <←> key or <→> key to choose among the selections on the menu bar, and then press <Enter> to get into the sub screen.

3.1.2 Navigation Keys

Please check the following table for the function description of each navigation key.

Navigation Key(s)	Function Description
← / →	Moves cursor left or right to select Screens
↑ / ↓	Moves cursor up or down to select items
+ / -	To change option for the selected items
<Tab>	Switch to next function
<Enter>	To bring up the selected screen
<PGUP>	Go to the previous page
<PGDN>	Go to the next page
<HOME>	Go to the top of the screen
<END>	Go to the bottom of the screen
<F1>	To display the General Help Screen
<F7>	Discard changes and exit the UEFI SETUP UTILITY
<F9>	Load optimal default values for all the settings
<F10>	Save changes and exit the UEFI SETUP UTILITY
<F12>	Print screen
<ESC>	Jump to the Exit Screen or exit the current screen

3.2 Main Screen

Once you enter the UEFI SETUP UTILITY, the Main screen will appear and display the system overview. The Main screen provides system overview information and allows you to set the system time and date.

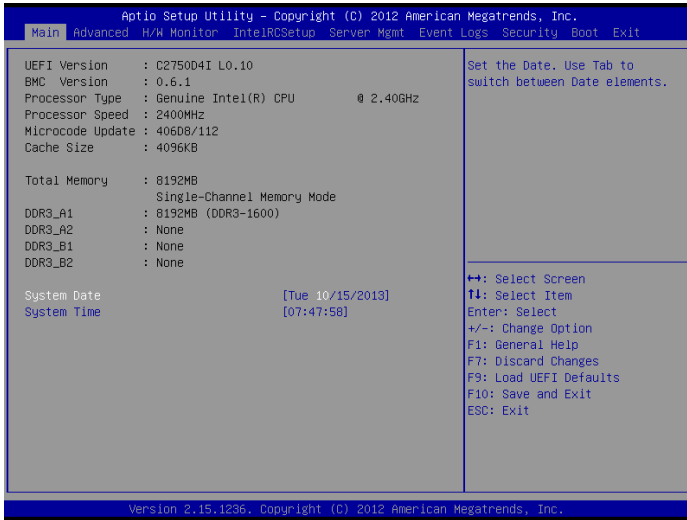

3.3 Advanced Screen

In this section, you may set the configurations for the following items: Easy RAID Installer, Storage Configuration, ACPI Configuration, Super IO Configuration, Serial Port Console Redirection, PCI Subsystem Settings, PLX 8608 Configuration, Voltage and Instant Flash.

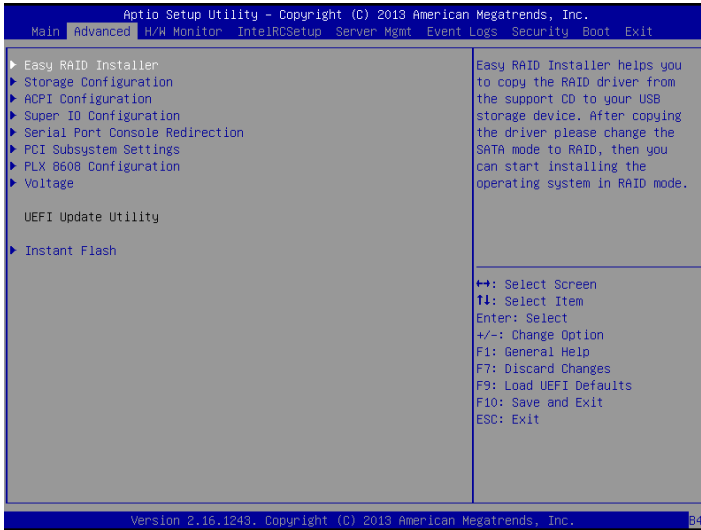

Setting wrong values in this section may cause the system to malfunction.

Instant Flash

Instant Flash is a UEFI flash utility embedded in Flash ROM. This convenient UEFI update tool allows you to update system UEFI without entering operating systems first like MS-DOS or Windows. Just save the new UEFI file to your USB flash drive, floppy disk or hard drive and launch this tool, then you can update your UEFI only in a few clicks without preparing an additional floppy diskette or other complicated flash utility. Please be noted that the USB flash drive or hard drive must use FAT32/16/12 file system. If you execute Instant Flash utility, the utility will show the UEFI files and their respective information. Select the proper UEFI file to update your UEFI, and reboot your system after the UEFI update process is completed.

3.3.1 Easy Raid Installer

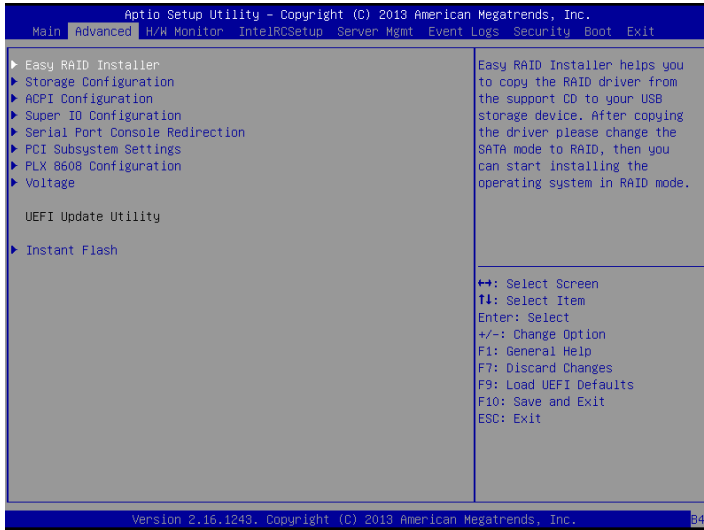

Easy RAID Installer can help you to copy the RAID driver from a support CD to your USB storage device. After copying the RAID driver to your USB storage device, please change “SATA Mode” to “RAID”, then you can start installing the OS in RAID mode.

3.3.2 Storage Configuration

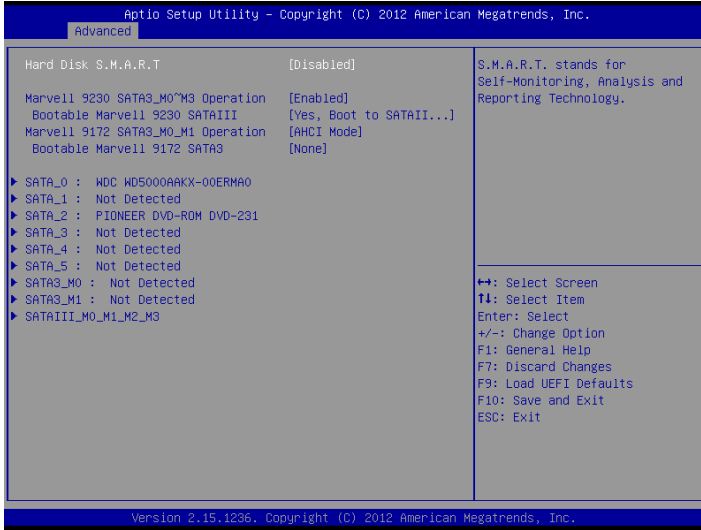

Hard Disk S.M.A.R.T.

Use this item to enable or disable the S.M.A.R.T. (Self-Monitoring, Analysis, and Reporting Technology) feature.

Marvell 9230 SATA3_M0~M3 Operation

This item is for Marvell 9230 SATA3_M0~M3 ports. Use this to select Marvell SATA3 mode. Configuration options: [Enabled] and [Disabled]. The default value is [Enabled].

Bootable Marvell 9230 SATAIII

Use this to enable or disable Marvell SATA Boot ROM.

Marvell 9172 SATA3_M0_M1 Operation

This item is for Marvell 9172 SATA3_M0 and M1 ports. Use this to select Marvell SATA3 mode. Configuration options: [Disabled], [IDE Mode], [AHCI Mode] and [RAID Mode]. The default value is [AHCI Mode].

Bootable Marvell 9172 SATA3

Use this to enable or disable Marvell SATA Boot ROM.



We recommend to use Intel® SATA ports (SATA_0 to SATA_5 ports) for your bootable devices. This will minimum your boot time and get the best performance. But if you still want to boot from Marvell SATA3 controller, you can still enable this in UEFI.

3.3.3 ACPI Configuration



ACPI HPET Table

Enable the High Precision Event Timer for better performance.

PCIE Devices Power On

Use this item to enable or disable PCIE devices to turn on the system from the power-soft-off mode.

RTC Alarm Power On

Use this item to enable or disable RTC (Real Time Clock) to power on the system.

3.3.4 Super IO Configuration

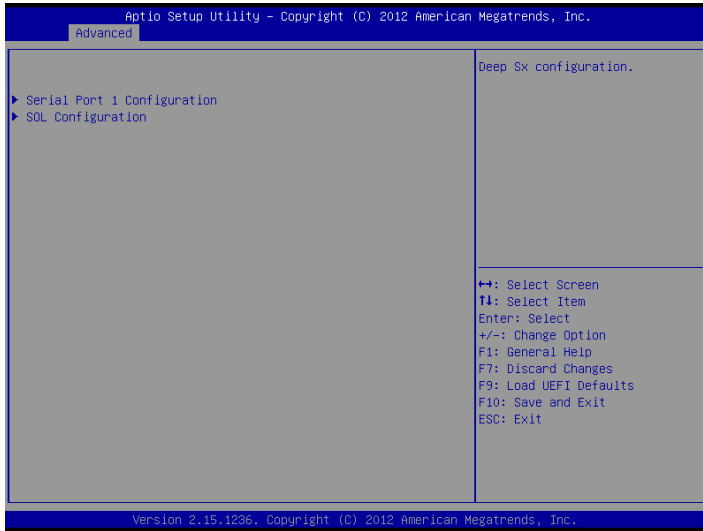

Serial Port 1 Configuration

Use this item to configure the onboard serial port 1.

SOL Configuration

Use this item to configure the onboard serial port 2.

3.3.5 Serial Port Console Redirection

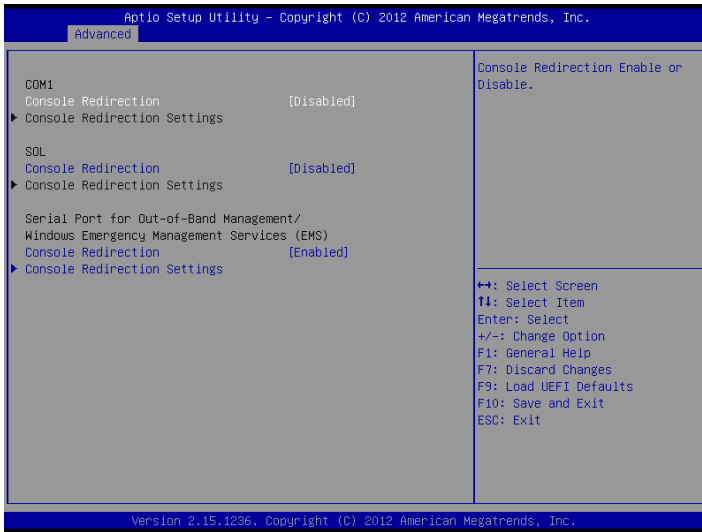

Console Redirection

Use this option to enable or disable Console Redirection.

Console Redirection Settings

Use this option to configure Console Redirection Settings.

3.3.6 PCI Subsystem Settings

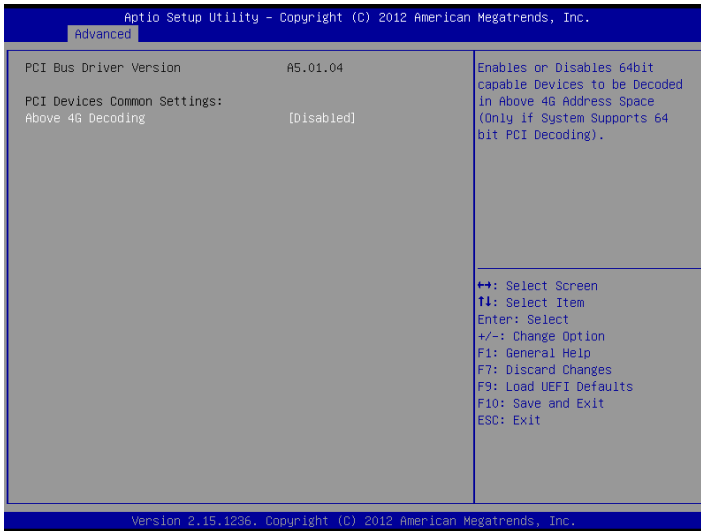

Above 4G Decoding

Use this option to enable or disable 64bit capable devices to be decoded in above 4G address space (only if system supports 64bit PCI decoding).

3.3.7 PLX 8608 Configuration

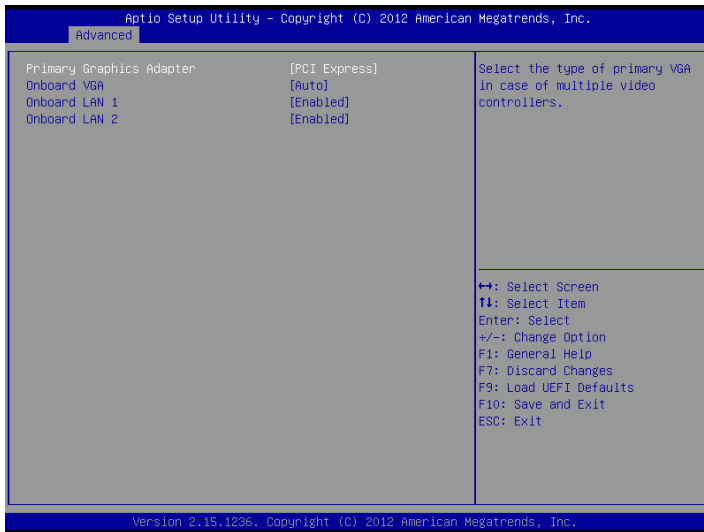

Primary Graphics Adapter

This allows you to select [Onboard] or [PCI Express] as the boot graphic adapter priority. The default value is [PCI Express].

Onboard VGA

This allows you to enable or disable the Onboard VGA feature.

Onboard LAN1

This allows you to enable or disable the Onboard LAN1 feature.

Onboard LAN2

This allows you to enable or disable the Onboard LAN2 feature.

3.3.8 Voltage

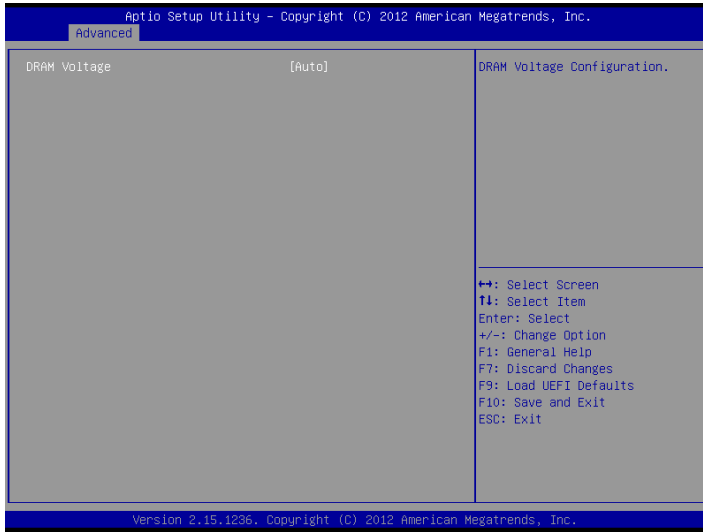

DRAM Voltage

Use this to select DRAM Voltage. The default value is [Auto].

3.4 H/W Monitor Screen (Hardware Health Event Monitoring)

In this section, it allows you to monitor the status of the hardware on your system, including the parameters of the CPU temperature, motherboard temperature and the critical voltage.

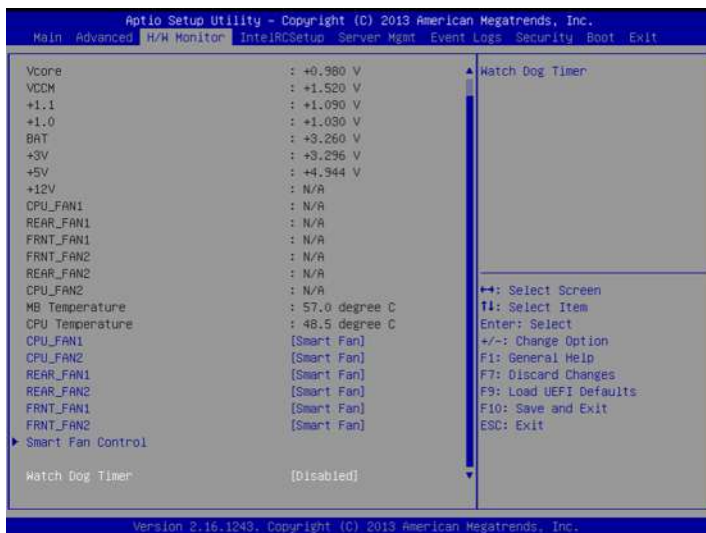

CPU_FAN1 Setting

This allows you to set the speed of CPU fan 1. The default value is [Smart Fan].

CPU_FAN2 Setting

This allows you to set the speed of CPU fan 2. The default value is [Smart Fan].

REAR_FAN1 Setting

This allows you to set the speed of REAR Fan 1. The default value is [Smart Fan].

REAR_FAN2 Setting

This allows you to set the speed of REAR Fan 2. The default value is [Smart Fan].

FRNT_FAN1 Setting

This allows you to set the speed of FRNT Fan 1. The default value is [Smart Fan].

FRNT_FAN2 Setting

This allows you to set the speed of FRNT Fan 2. The default value is [Smart Fan].

Watch Dog Timer

This allows you to enable or disable the Watch Dog Timer. The default value is [Disabled].

3.5 IntelRCSetup

In this section, you may set the configurations for the following items: Processor Configuration, North Bridge Chipset Configuration, South Bridge Chipset Configuration and System Event Log.

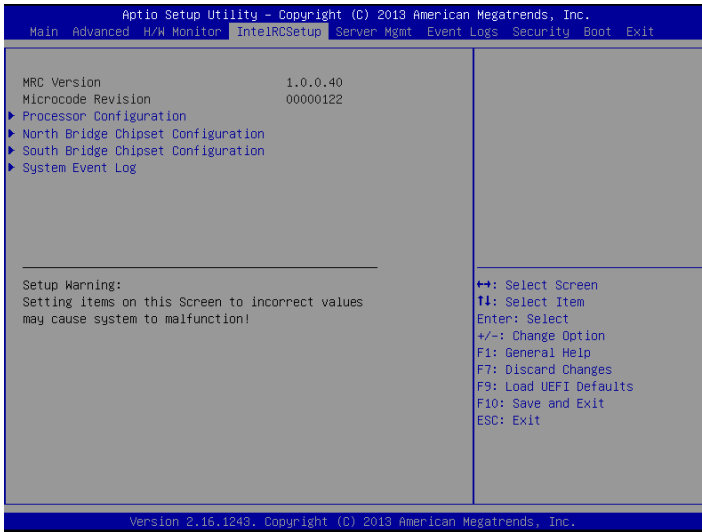

3.5.1 Processor Configuration

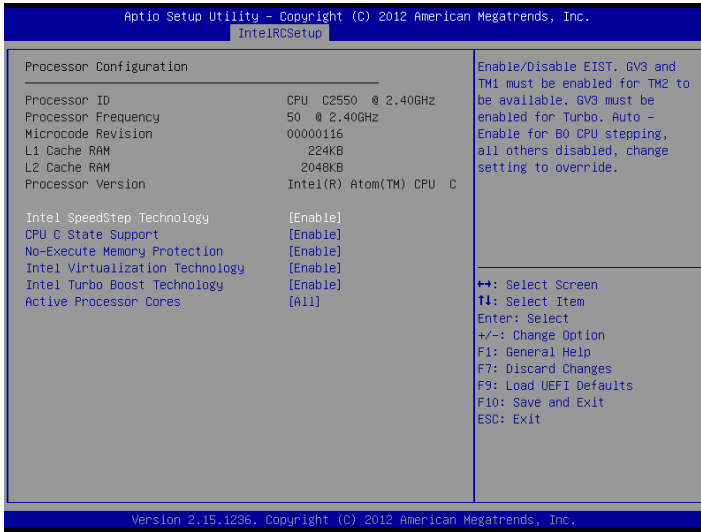

Intel SpeedStep Technology

Intel SpeedStep technology is Intel's new power saving technology. Processors can switch between multiple frequencies and voltage points to enable power saving. The default value is [Enabled]. Configuration options: [Enabled] and [Disabled]. This item will be hidden if the current CPU does not support Intel SpeedStep technology.



Please note that enabling this function may reduce CPU voltage and lead to system stability or compatibility issues with some power supplies. Please set this item to [Disabled] if above issues occur.

CPU C State

Use this to enable or disable the support of CPU C State.

No-Execute Memory Protection

Processors with No-Execution Memory Protection Technology may prevent certain classes of malicious buffer overflow attacks.

Intel Virtualization Technology

When this option is set to [Enabled], a VMM (Virtual Machine Architecture) can utilize the additional hardware capabilities provided by Vanderpool Technology. This option will be hidden if the installed CPU does not support Intel Virtualization Technology.

Intel Turbo Boost Technology

Use this item to enable or disable Intel Turbo Boost Mode Technology. Turbo Boost Mode allows processor cores to run faster than marked frequency in specific conditions. The default value is [Enabled].

Active Processor Cores

Use this item to select the number of cores to enable in each processor package. The default value is [All].

3.5.2 North Bridge Configuration

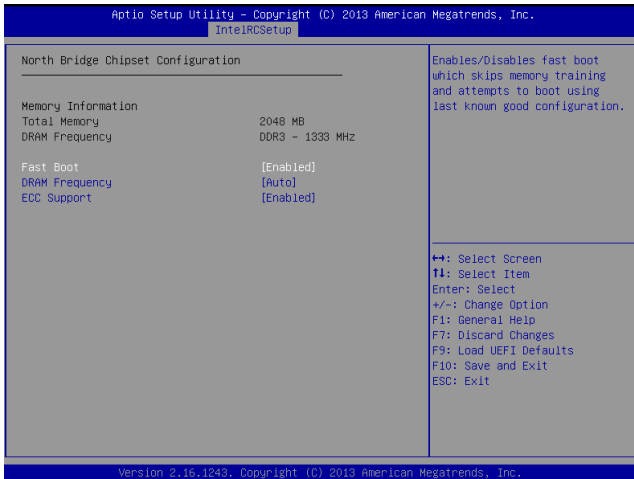

Fast Boot

Use this item to enable to disable fast boot which skips memory training and attempts to boot using last known good configuration.

DRAM Frequency

If [Auto] is selected, the motherboard will detect the memory module(s) inserted and assign the appropriate frequency automatically.

ECC Support

Use this item to enable or disable DDR ECC Support.

3.5.3 South Bridge Chipset Configuration

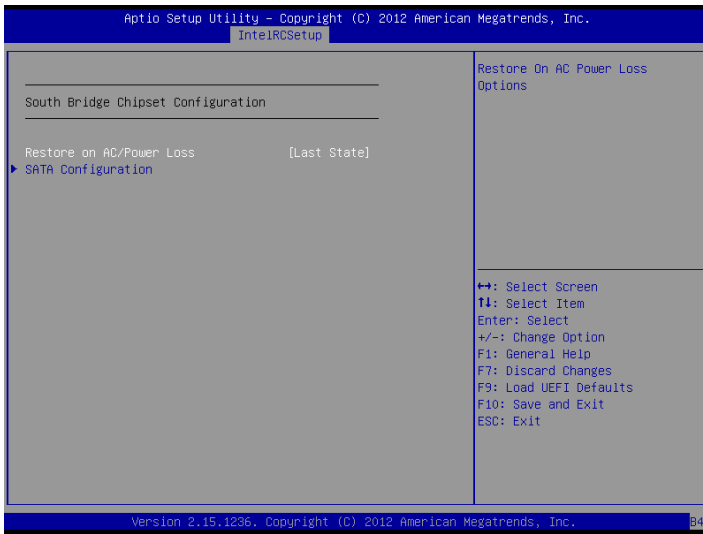

Restore on AC/Power Loss

Select the power state after a power failure. If [Power Off] is selected, the power will remain off when the power recovers. If [Power On] is selected, the system will start to boot up when the power recovers.

SATA Configuration

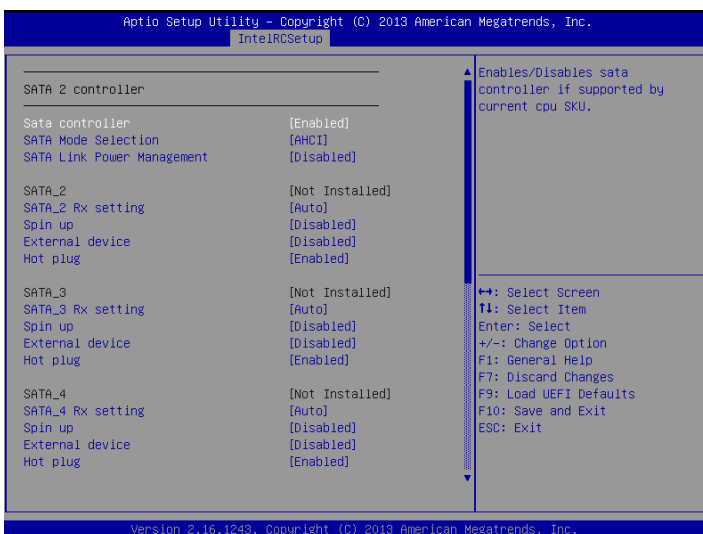

SATA 2 Controller / SATA 3 Controller

Use this item to enable or disable SATA Controller.

SATA Mode Selection

Use this to select SATA mode. Configuration options: [Disabled], [IDE Mode] and [AHCI Mode]. The default value is [AHCI Mode].



AHCI (Advanced Host Controller Interface) supports NCQ and other new features that will improve SATA disk performance but IDE mode does not have these advantages.

SATA Link Power Management

Use this item to configure SATA Aggressive Link Power Management.

SATA_x

Depending on how many SATA ports you have, you will see SATA_x (x means number) listed on the screen, with its status indicated as SATA device [(Model Name)] or [Not Detected].

SATA_x Rx Setting

Adjust SATA DTLE DATA Values (0-15).

Spin Up

If enabled for any of ports, Staggered Spin Up will be performed and only the drives which have this option enabled will spin up at boot. Otherwise all drives spin up at boot.

External Device

Use this item to enable SATA safe removal notifications. Please note that the SATA device will be downgraded to SATA2.

Hot Plug

Designates this port as Hot Pluggable.

3.5.4 System Event Log

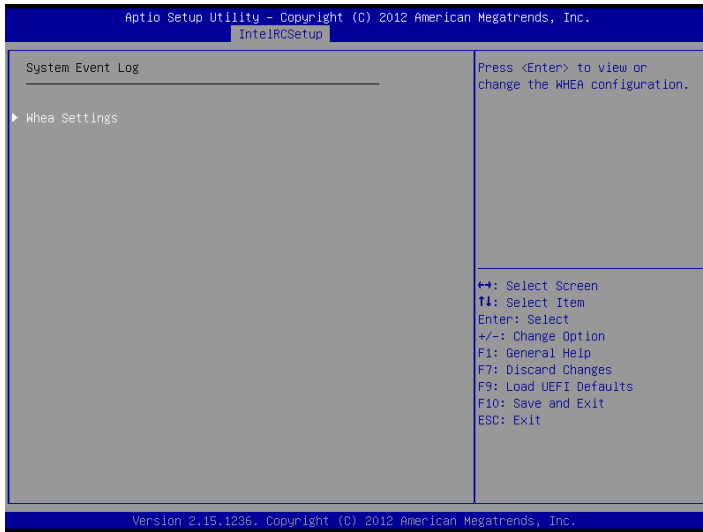

Whea Settings

Use this option to configure Windows Hardware Error Architecture.

3.6 Server Management



Wait For BMC

Wait For BMC response for specified time out. In PILOTII, BMC starts at the same time when BIOS starts during AC power ON. It takes around 30 seconds to initialize Host to BMC interfaces.

System Event Log

Enter to configure System Event Logging features during boot.

BMC Network Configuration

Press <Enter> to configure BMC Network parameters.

Configuration Address Source

Select to configure BMC network parameters statically or dynamically (by BIOS or BMC). Configuration options: [Unspecified], [Static], and [Dynamic].

Unspecified: BMC network parameters are configured by BMC itself.

Static: Manually enter the IP Address, Subnet Mask and Gateway Address in the BIOS for BMC LAN channel configuration.

Dynamic: IP address, Subnet Mask and Gateway Address are automatically assigned by the network's DHCP server.

To configure BMC network parameters using the BIOS setup, select either [Static] or [Dynamic] option.

To configure BMC network parameters using the BMC web interface, select [Unspecified] option.



When [Dynamic] or [Static] is selected, do NOT modify the BMC network settings on the IPMI web page.



The default login information for the IPMI web interface is:

Username: admin

Password: admin

Username: admin
Password: *****
[Send Password](#)

Language: English

Please refer to the table below for the LAN interface mapping to check the MAC address through either BIOS or Web interface.



BMC LAN Interface Mapping Table

I/O Panel	BIOS Menu	IPMI Web Page
LAN1 Port (NCSI)	Lan Channel 1	eth0
IPMI Port	Lan Channel 2	eth1

BIOS Menu

Server Mgmt
tab

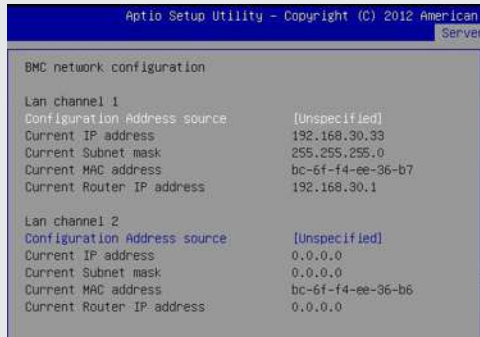

(Example image only)

IPMI Web Page

Configuration
> Network
Settings

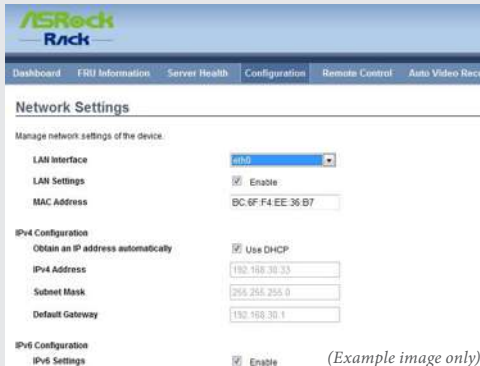

(Example image only)

For more instructions on how to set up remote control environment and use the IPMI management platform, please refer to the IPMI Configuration User Guide or go to the Support website at: <http://www.asrockrack.com/support/ipmi.asp>

BMC Mac Backup Tool

Use this to restore BMC Mac from the backup.

3.7 Event Logs

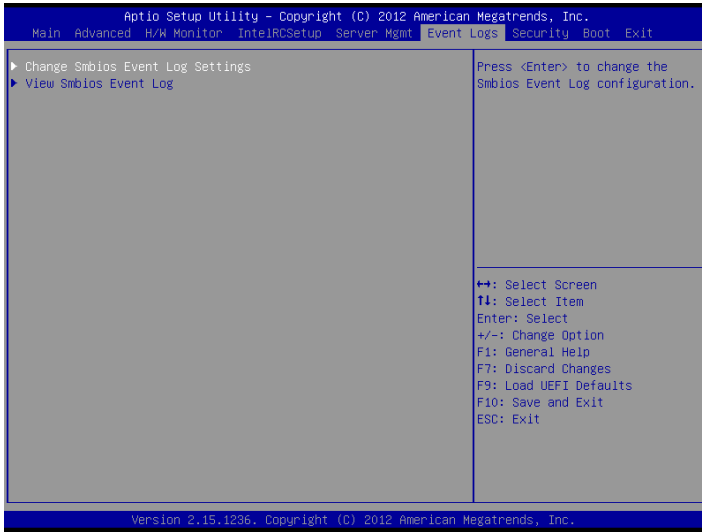

Change Smbios Event Log Settings

This allows you to configure the Smbios Event Log Settings.

View Smbios Event Log

This allows you to view the Smbios Event Log.

3.8 Security Screen

In this section, you may set or change the supervisor/user password for the system. For the user password, you may also clear it.



Supervisor Password

Set or change the password for the administrator account. Only the administrator has authority to change the settings in the UEFI Setup Utility. Leave it blank and press enter to remove the password.

User Password

Set or change the password for the user account. Users are unable to change the settings in the UEFI Setup Utility. Leave it blank and press enter to remove the password.

3.9 Boot Screen

In this section, it will display the available devices on your system for you to configure the boot settings and the boot priority.

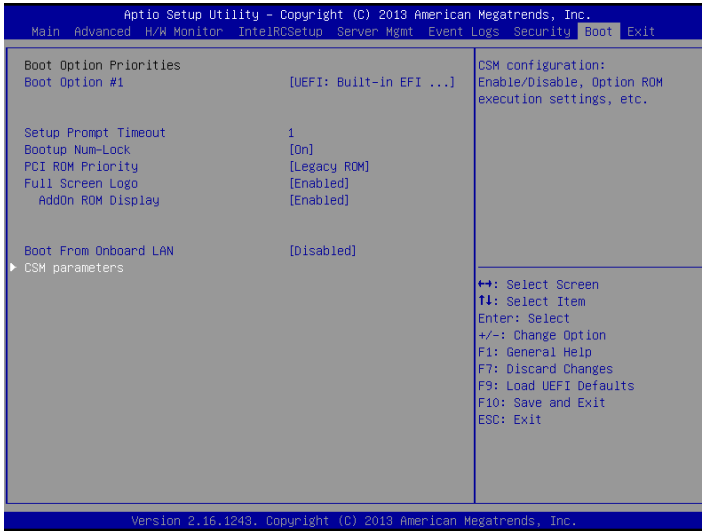

Boot Option #1

Use this item to set the system boot order.

Setup Prompt Timeout

This shows the number of seconds to wait for setup activation key.

Bootup Num-Lock

If this item is set to [On], it will automatically activate the Numeric Lock function after boot-up.

PCI ROM Priority

Use this item to adjust PCI ROM Priority. The default value is [LegacyROM]

Full Screen Logo

Use this item to enable or disable OEM Logo. The default value is [Enabled].

AddOn ROM Display

Use this option to adjust AddOn ROM Display. If you enable the option “Full Screen Logo” but you want to see the AddOn ROM information when the system boots, please select

[Enabled]. Configuration options: [Enabled] and [Disabled]. The default value is [Enabled].

Boot From Onboard LAN

Use this item to enable or disable the Boot From Onboard LAN feature.

CSM Parameters

Use this option to configure the parameters of OpROM execution, boot options filter, etc.

Boot Option Filter

Use this option to control what devices system can boot to. Configuration options: [UEFI and Legacy], [Legacy only] and [UEFI only].

Launch Storage OpROM Policy

Select UEFI only to run those that support UEFI option ROM only. Select [Legacy only] to run those that support legacy option ROM only.

3.10 Exit Screen



Save Changes and Exit

When you select this option, the following message “Save configuration changes and exit setup?” will pop-out. Select [Yes] to save the changes and exit the UEFI SETUP UTILITY.

Discard Changes and Exit

When you select this option, the following message “Discard changes and exit setup?” will pop-out. Select [Yes] to exit the UEFI SETUP UTILITY without saving any changes.

Discard Changes

When you select this option, the following message “Discard changes?” will pop-out. Select [Yes] to discard all changes.

Load UEFI Defaults

Load UEFI default values for all the setup questions. F9 key can be used for this operation.

Chapter 4 Software Support

4.1 Install Operating System

This motherboard supports Microsoft® Windows® Server 2008 R2 SP1 (64 bit) / 2012 (64 bit) / Linux compliant. Because motherboard settings and hardware options vary, use the setup procedures in this chapter for general reference only. Refer your OS documentation for more information.

**Please download the Intel® SATA Floppy Image driver from the ASRock Rack's website (www.asrockrack.com) to your USB drive or simply install the SATA driver from the Support CD while installing OS in SATA RAID mode.*

4.2 Support CD Information

The Support CD that came with the motherboard contains necessary drivers and useful utilities that enhance the motherboard's features.

4.2.1 Running The Support CD

To begin using the support CD, insert the CD into your CD-ROM drive. The CD automatically displays the Main Menu if "AUTORUN" is enabled in your computer. If the Main Menu does not appear automatically, locate and double click on the file "ASRSetup.exe" from the root folder in the Support CD to display the menu.

4.2.2 Drivers Menu

The Drivers Menu shows the available device's drivers if the system detects installed devices. Please install the necessary drivers to activate the devices.

4.2.3 Utilities Menu

The Utilities Menu shows the application softwares that the motherboard supports. Click on a specific item then follow the installation wizard to install it.

4.2.4 Contact Information

If you need to contact ASRock Rack or want to know more about ASRock Rack, welcome to visit ASRock Rack's website at <http://www.ASRockRack.com>; or you may contact your dealer for further information.

Chapter 5 Troubleshooting

5.1 Troubleshooting Procedures

Follow the procedures below to troubleshoot your system.



Always unplug the power cord before adding, removing or changing any hardware components. Failure to do so may cause physical injuries to you and damages to motherboard components.

1. Disconnect the power cable and check whether the PWR LED is off.
2. Unplug all cables, connectors and remove all add-on cards from the motherboard. Make sure that the jumpers are set to default settings.
3. Confirm that there are no short circuits between the motherboard and the chassis.
4. Install a CPU and fan on the motherboard, then connect the chassis speaker and power LED.

If there is no power...

1. Confirm that there are no short circuits between the motherboard and the chassis.
2. Make sure that the jumpers are set to default settings.
3. Check the settings of the 115V/230V switch on the power supply.
4. Verify if the battery on the motherboard provides ~3VDC. Install a new battery if it does not.

If there is no video...

1. Try replugging the monitor cables and power cord.
2. Check for memory errors.

If there are memory errors...

1. Verify that the DIMM modules are properly seated in the slots.
2. Use recommended DDR3 1600/1333/1066 non ECC, unbuffered DIMMs.
3. If you have installed more than one DIMM modules, they should be identical with the same brand, speed, size and chip-type.
4. Try inserting different DIMM modules into different slots to identify faulty ones.
5. Check the settings of the 115V/230V switch on the power supply.

Unable to save system setup configurations...

1. Verify if the battery on the motherboard provides ~3VDC. Install a new battery if it does not.
2. Confirm whether your power supply provides adequate and stable power.

Other problems...

1. Try searching keywords related to your problem on ASRock Rack's FAQ page:
<http://www.asrockrack.com/support>

5.2 Technical Support Procedures

If you have tried the troubleshooting procedures mentioned above and the problems are still unsolved, please contact ASRock Rack's technical support with the following information:

1. Your contact information
2. Model name, BIOS version and problem type
3. System configuration
4. Problem description

You may contact ASRock Rack's technical support at:

<http://www.asrockrack.com/support/tsd.asp>

5.3 Returning Merchandise for Service

For warranty service, the receipt or a copy of your invoice marked with the date of purchase is required. By calling your vendor or going to our RMA website (<http://event.asrockrack.com/tsd.asp>) you may obtain a Returned Merchandise Authorization (RMA) number.

The RMA number should be displayed on the outside of the shipping carton which is mailed prepaid or hand-carried when you return the motherboard to the manufacturer. Shipping and handling charges will be applied for all orders that must be mailed when service is complete.

This warranty does not cover damages incurred in shipping or from failure due to alteration, misuse, abuse or improper maintenance of products.

Contact your distributor first for any product related problems during the warranty period.

Chapter 6: Net Framework Installation Guide

To let Intel® RSTe works properly, it is required to install Net Framework. Please follow the steps below to enable “.Net Framework” feature on Microsoft® Windows® Server 2008 R2.

6.1 Installing .Net Framework 3.5.1 (For Server 2008 R2)

1. Double-click the Server Manager icon in the Windows system tray.



2. Click Add Features in the right hand pane.



3. Check the box next to .Net Framework 3.5.1 and then click **Next**.

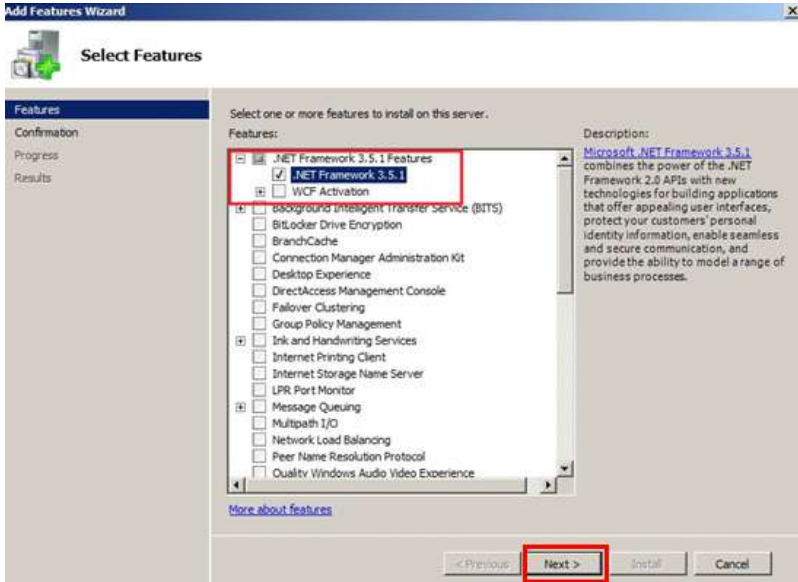

4. Click **Next** to continue.

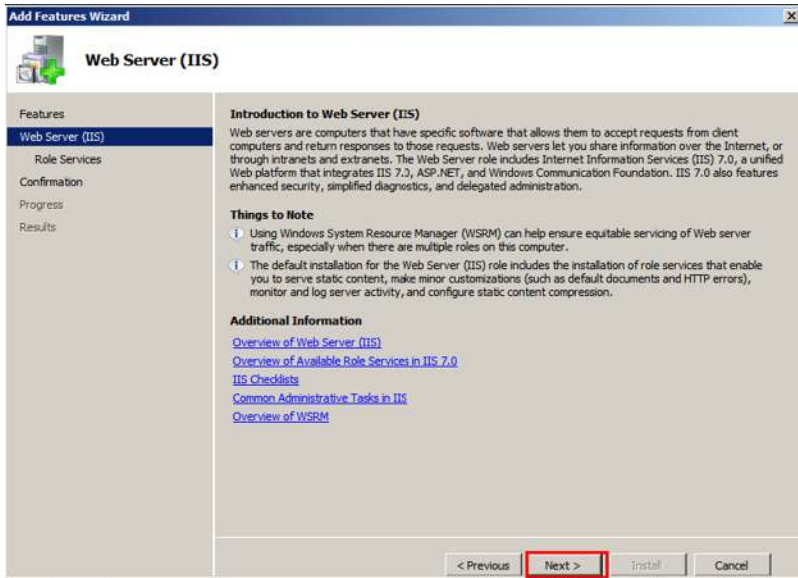

5. Click **Install** to start installing .Net Framework 3.5.1.

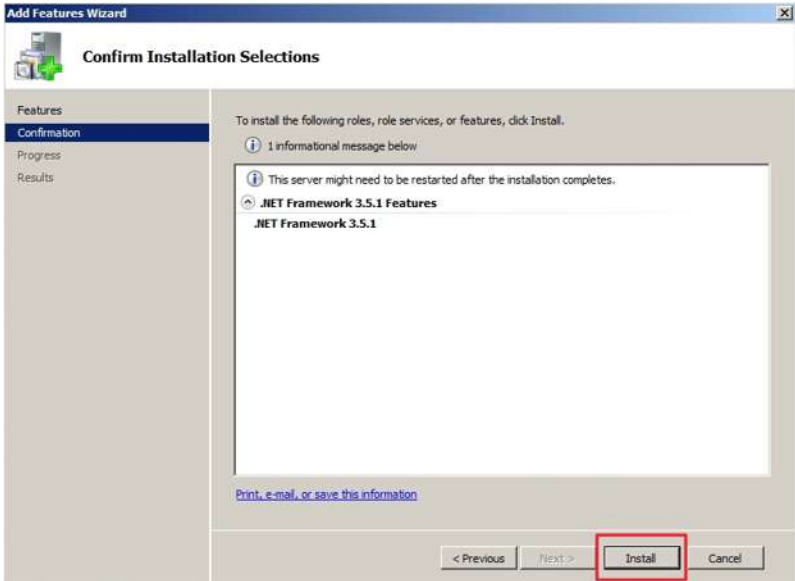

6. After the installation completes, click **Close**.

